

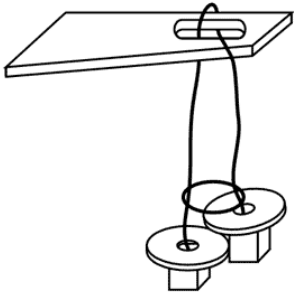

IQ Collection™ Triple Threat™

Brain Drain



REMOVE AND THEN REPLACE THE RING.

1 Hold puzzle as shown.

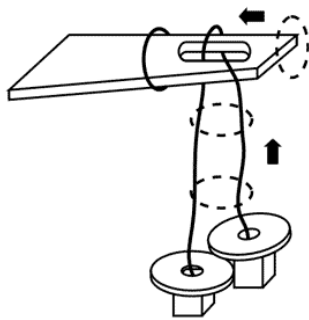

2 Slide the metal ring up the strings and over the thin end of the puzzle until it is positioned as shown.

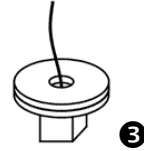

3 Move one of the round wooden disks, not the cube, up the string, through the slot and back down the string until it lands on top of the other disk. Remember to always follow the string.

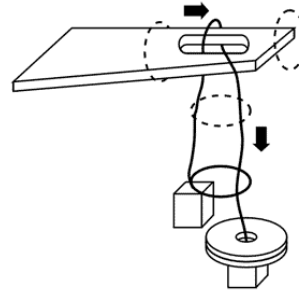

4 Slide the metal ring back over the thin end of the puzzle and down the strings.

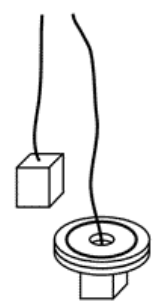

5 Pass the metal ring over the cube, until it is positioned on top of the disks as shown.

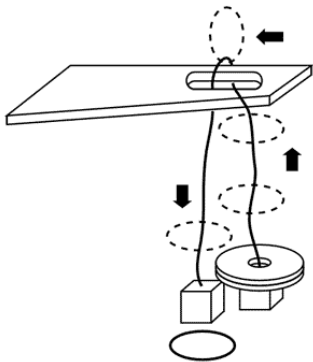

6 Take the metal ring back up the string, through the slot and back down the string until it falls off the end of the cube and is free. Reverse to reassemble.

Brain Twister

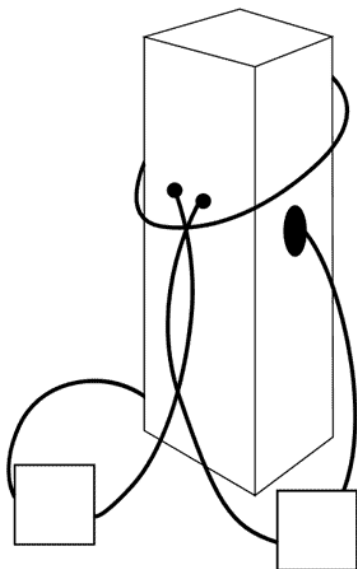

TRY TO GET BOTH CUBES ONTO THE ONE CORD

1 Position the puzzle as it is in the sketch. Work loop "A" loose and pull it up over the block and pass one of the balls through loop "A". Now pull the two cords which run through the top hole. You will also pull the cords supporting the balls through. Pass the ball you selected in stage 1 through the loop now formed. Pull the cords back through the hole and you will now be able to slide the ball through to the other ball.

Reverse to reassemble.

Manufactured and distributed by:

Family Games America FGA Inc. Montreal, Quebec, Canada www.familygamesamerica.com

Under license from Family Games America FGA Inc.

Brain Strain

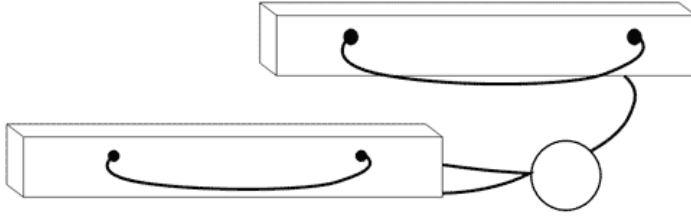

COMPLETELY REMOVE THE CORD AND BALL FROM THE BLOCKS.

① Pull the loop at the center of one of the blocks about 6" (inches) through. Then thread the loop through the hole on the same block (the one nearest the ball). Pass the loop over the ball and other block, then pull the loop back through the hole. The cord will now be free from the block. Reverse to reassemble.

Wedding Vows

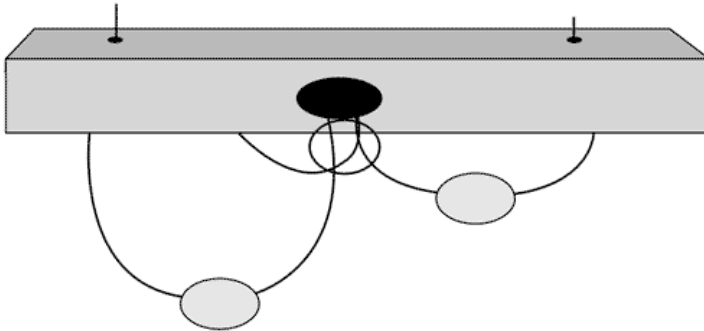

MOVE BEADS TO ONE SIDE

① Loosen the knot formed in the hole through the bar and work one disc through the first loop. Carefully pull the knot through the hole. The disc can now be slid to the other side of the knot. Pull the knot back through the hole and slide the disc through the final loop. The disc should now be on the opposite side! Reverse to reassemble.

Brain Tester

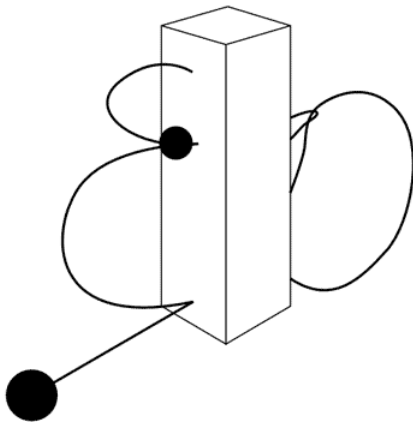

REMOVE THE SMALL BEAD

① Pull the loop through the center hole from the opposite side to the bead. Some loosening of the cord may be required. Continue by threading the loop through the end hole towards the ball. Pass the ball through the loop, draw the loop back through the two holes and the bead will be free from the puzzle. Reverse to reassemble.

Cuckoo's Nest

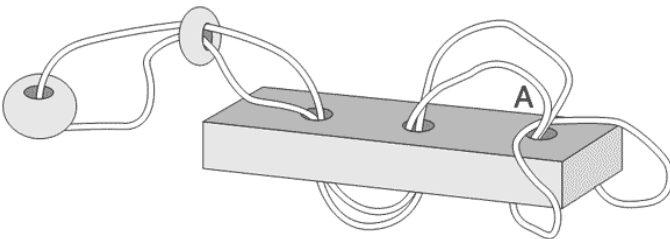

REMOVE THE SMALL BEAD

① Pull the cord through all 3 holes so that the ring is tight up against the bar and the loop at the opposite end is fully loosened. Thread the end of loop "A" through the center hole nearest the ring. Now pass the ring through loop "A" and thread loop "A" back through the same holes as in step 2. The cord should be able to be worked free from the bar and the ring removed. Reverse to reassemble.

Manufactured and distributed by:

Family Games America FGA Inc. Montreal, Quebec, Canada www.familygamesamerica.com

Under license from Family Games America FGA Inc.

Iron Maiden

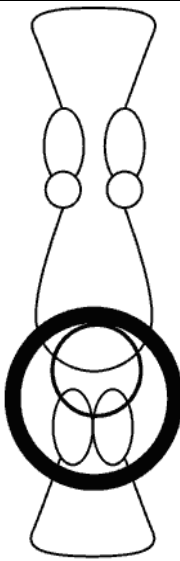
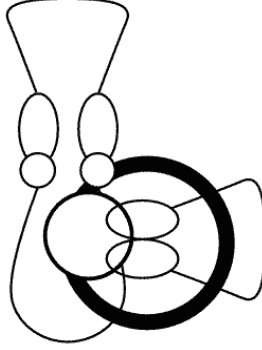
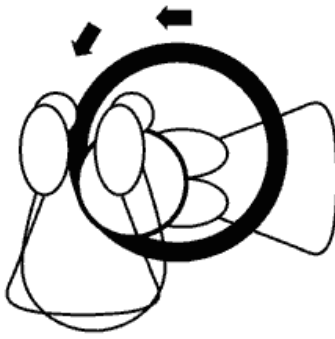
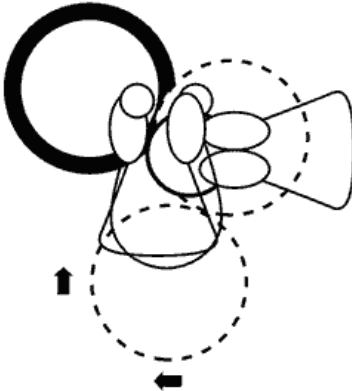
		
<p>❶</p>	<p>❷ Flip the Maiden upside down.</p>	<p>❸ Move the large ring to one side.</p>
		
<p>❹ Fold the body in half.</p>	<p>❺ Move the ring down and around the frame. The ring should be free.</p>	

"A" Puzzle

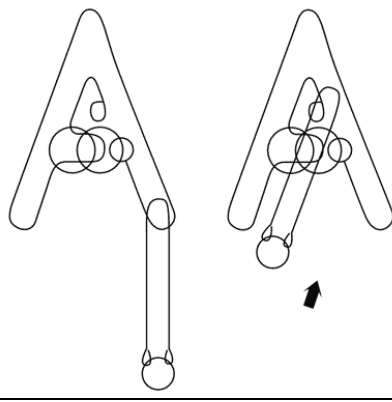
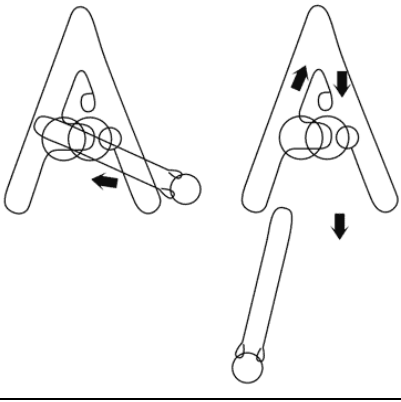
	
<p>❶ Move handle in between the two rings. Move handle through the left ring.</p>	<p>❷ Move handle around inside of "A". Move handle through the right ring. Move handle around the inside of "A". You should be free from puzzle. Reverse to reassemble.</p>

Manufactured and distributed by:

Family Games America FGA Inc. Montreal, Quebec, Canada www.familygamesamerica.com

Under license from Family Games America FGA Inc.